



STARFISH PRO

SISTEMA DI POSTURA



Fatturare a: _____

Ragione sociale: _____

Via: _____

Città: _____ C.A.P. _____

Provincia: _____

Tel. _____ Fax: _____

Spedire a: _____

Data ordine: _____

Num. Ordine: _____

Quantità richiesta: _____

DESCRIZIONE

- Braccioli regolabili in altezza e lunghezza;
- Poggiatesta lungo;
- Schienale regolabile in altezza ed inclinazione;
- Pedana separata regolabile in altezza;
- Base basculante;
- Supporti toracali regolabili in altezza, larghezza e inclinazione.

Ordine Preventivo

Inviare l'ordine via fax. +39 0341 360931

o via e-mail: ordini@creha.it.

Per info: Tel. +39 0341 372350.

CODICE*

➡ 18.09.39.021 ➡ 18.09.39.030 x 2

➡ 18.09.39.133 ➡ 18.09.39.027

➡ 18.09.39.136 ➡ 18.09.39.103

➡ 18.09.39.157 ➡ 18.09.39.166 x 2

➡ 18.09.39.160 ➡ 18.09.39.148 x 2

➡ 18.09.39.163 ➡ 18.09.39.003

➡ 18.09.39.169 ➡ 18.09.39.036

* i codici sono indicativi e non garantiscono integrazione completa del prezzo

CODICE RDM

➡ 1724828

4.519,00 €

LISTINO PREZZI

MISURE STARFISH PRO

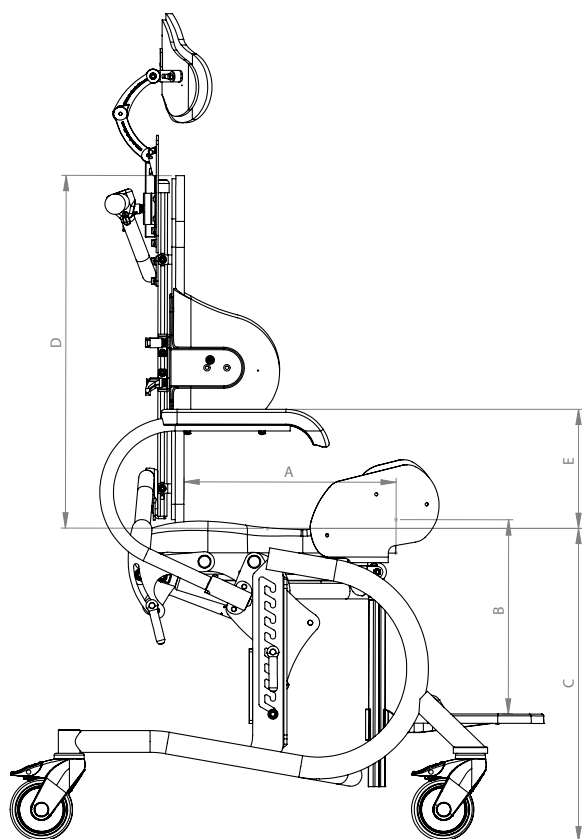

RIFERIMENTI	MISURE	1	2	3
DATI UTENTE				
	Peso	120 kg	120 kg	150 kg
	Altezza	120÷145 cm	140÷175 cm	170÷200 cm
DATI SEDUTA				
	Larghezza seduta	38 cm	45 cm	51 cm
A	Profondità seduta	30÷38 cm	36÷47 cm	45÷55 cm
	Contenimento laterale ginocchio	16,5 cm	18,5 cm	20 cm
C	Altezza seduta da terra regolata manualmente	53÷63 cm		

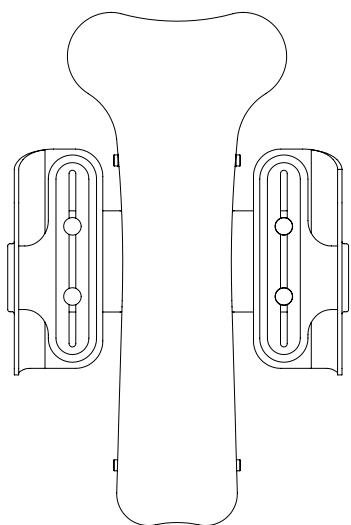
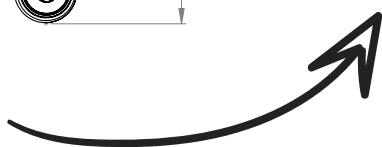

MISURE	1	2	3
DATI SCHIENALE			
Altezza telaio schienale	46 cm	56 cm	66 cm
Distanza min-max supporti toracali	21-30cm	24-34cm	30-40cm
Reclinazione schienale	10° + 35°		

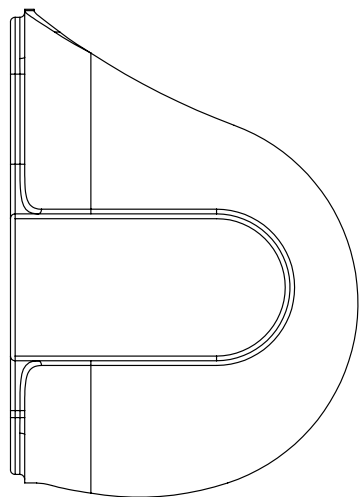

MISURE	1	2	3
DATI SUPPORTI TORACALI			
Profondità supporti toracali	14 cm	17 cm	20 cm
Altezza supporti toracali	21 cm	23 cm	26 cm

Pedana unica

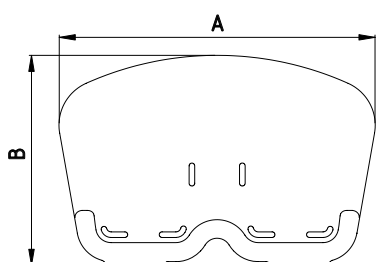

RIFERIMENTI	MISURE	1	2	3
DATI PEDANA				
A	Larghezza pedana unica	34,5 cm	38 cm	38 cm
B	Altezza pdana unica	22,5 cm	25,5 cm	31 cm
A	Larghezza pedana separata	16 cm	18 cm	18 cm
B	Altezza pedana separata	22 cm	25,5 cm	30,5 cm

Pedana separata

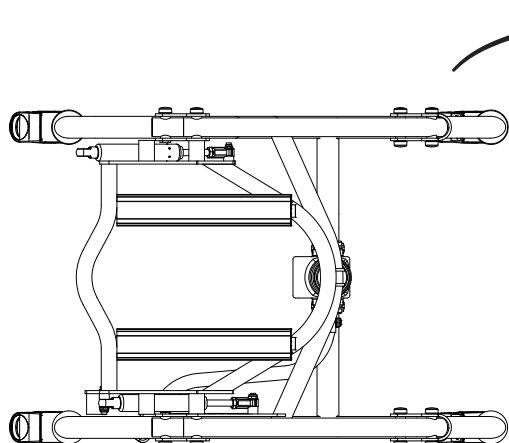
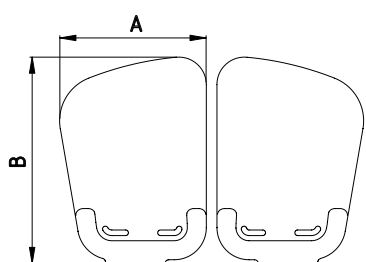

MISURE	1	2	3
DATI UTENTE			
Peso	120 kg	120 kg	150 kg
Altezza	120-145 cm	140-175 cm	170-200 cm
DATI BASE			
Larghezza base	54 cm	54 cm	59 cm
Lunghezza base	69 cm	69 cm	79 cm
Diametro ruote	10 cm	10 cm	10 cm
Peso totale	31 kg	33 kg	35 kg
Portata massima	120 kg	120 kg	150 kg
Basculamento	-5° +30°	-5° +30°	-5° +30°

DOTAZIONE BASE & ACCESSORI

CODICE	NOME	MISURA	PREZZO	IVA	COD. DM	
<input type="checkbox"/> 689401	Starfish pro seduta intera su base da interno	1	4.519,00 €	4%		⇒ 
<input type="checkbox"/> 689402		2	4.519,00 €	4%		
<input type="checkbox"/> 689403		3	4.519,00 €	4%		
<input type="checkbox"/> 689406	Starfish pro seduta divisa su base da interno	1	4.519,00 €	4%		
<input type="checkbox"/> 689407		2	4.519,00 €	4%		
<input type="checkbox"/> 689408		3	4.519,00 €	4%		
<input type="checkbox"/> 6894 71 - 76	Contenimento laterale gambe	1	-	4%		⇒ 
<input type="checkbox"/> 6894 72 - 77		2	-	4%		
<input type="checkbox"/> 6894 73 - 78		3	-	4%		
<input type="checkbox"/> 689431	Schienale Starfish	1	-	4%		
<input type="checkbox"/> 689432		2	-	4%		
<input type="checkbox"/> 689433		3	-	4%		
<input type="checkbox"/> 689441	Supporto tronco	1	-	4%		
<input type="checkbox"/> 689442		2	-	4%		
<input type="checkbox"/> 689443		3	-	4%		
<input type="checkbox"/> 689461	Bracciolo (paio)	1	-	4%		⇒ 
<input type="checkbox"/> 689462		2	-	4%		
<input type="checkbox"/> 689463		3	-	4%		
<input type="checkbox"/> 689456	Poggiatesta lungo	1	-	4%		⇒ 
<input type="checkbox"/> 689458		2	-	4%		
<input type="checkbox"/> 689501	Pedana Divisa	1	-	4%		⇒ 
<input type="checkbox"/> 689502		2	-	4%		
<input type="checkbox"/> 689503		3	-	4%		
ACCESSORI						
<input type="checkbox"/> 375211	Pettorina Pro	S	109,00 €	4%	18.09.39.145	
<input type="checkbox"/> 375311		M	109,00 €	4%	18.09.39.145	

CODICE	NOME	MISURA	PREZZO	IVA	COD. DM	
ACCESSORI						
<input type="checkbox"/> 375411	Pettorina Pro	L	109,00 €	4%	18.09.39.145	⇒ 
<input type="checkbox"/> 376521	Pettorina H	S	109,00 €	4%	18.09.39.145	⇒ 
<input type="checkbox"/> 376531		M	109,00 €	4%	18.09.39.145	
<input type="checkbox"/> 376541		L	109,00 €	4%	18.09.39.145	
<input type="checkbox"/> 374201	Cinghia pelvica	1				⇒ 
<input type="checkbox"/> 374211		2				
<input type="checkbox"/> 374221		3				
<input type="checkbox"/> 374232	Cinghia antirotazione bacino *	S	198,00 € *	4%	18.09.39.163	⇒ 
<input type="checkbox"/> 374241		M	198,00 € *	4%	18.09.39.163	
<input type="checkbox"/> 689284	PM supporto per pettorina (da ordinare sempre con pettorina)	UNICA	-	4%		⇒ 
<input type="checkbox"/> 689516	Imbottitura pedana divisa	1	128,00 €	4%		⇒ 
<input type="checkbox"/> 689517		2	128,00 €	4%		
<input type="checkbox"/> 689518		3	128,00 €	4%		
<input type="checkbox"/> 990252	Tavolino	2	298,00 €	4%	18.09.39.172	⇒ 
<input type="checkbox"/> 990253		3	298,00 €	4%	18.09.39.172	
<input type="checkbox"/> 990254		4	298,00 €	4%	18.09.39.172	
<input type="checkbox"/> 378111	Cinturino Soft polso	L	98,00 €	4%		⇒ 
<input type="checkbox"/> 378211		S	98,00 €	4%		
<input type="checkbox"/> 377111	Cinturino Caviglia	S	98,00 €	4%		⇒ 
<input type="checkbox"/> 377211		M	98,00 €	4%		
<input type="checkbox"/> 377311		L	98,00 €	4%		

CODICE	NOME	MISURA	PREZZO	IVA	COD. DM
ACCESSORI					
<input type="checkbox"/> 689533	Protezione Urina	M	128,00 €	4%	
<input type="checkbox"/> 689534	Protezione Urina	L	128,00 €	4%	
<input type="checkbox"/> 689526	Vaschetta urina	1-2	128,00 €	4%	
<input type="checkbox"/> 689527		3	128,00 €	4%	

* Prezzo in aggiunta alla dotazione base. Per l'acquisto singolo richiedere un preventivo.

NOTE





**Distribuzione in esclusiva italiana
di articoli riabilitativi unici e di qualità**

Creha Riabilitazione di Ortopedia Castagna Srl

Via Como 1 - 23896 Bevera di Sirtori (LC)

Fax 0341 360 931 - Tel. +39 0341 372 350

info@creha.it - www.creha.it